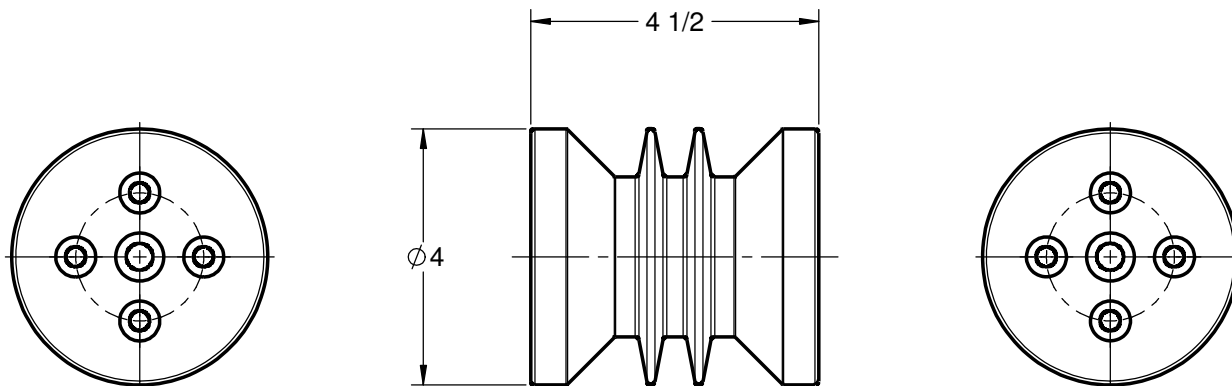

**GENERAL NOTES AND SPECIFICATIONS**

1. BASIC IMPULSE LEVEL: 75 kV
2. BODY MATERIAL: INDOOR BIS-A EPOXY, RED
3. INSERT MATERIAL: ZINC PLATED STEEL
4. WEIGHT: 3 lb(s)

**COMMON OPTIONS**

CHOOSE TOP AND BOTTOM MOUNTING CONFIGURATION FROM TABLE BELOW
 OTHER MOUNTING CONFIGURATIONS ARE ALSO AVAILABLE UPON REQUEST

SERIES ITEM	CONFIG
105-208-01	A1A1
105-208-02	A1A2
105-208-03	A2A2
105-208-04	A2A3
105-208-05	A2A6
105-208-06	A4A4
105-208-07	A4A5
105-208-08	A6A6
105-208-09	A7A7
105-208-10	A9A9
105-208-11	A6A8
105-208-12	A2A9
105-208-13	A1A8
105-208-14	A2A7

STANDARD MOUNTING INSERT CONFIGURATION

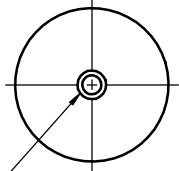
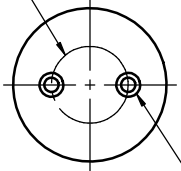
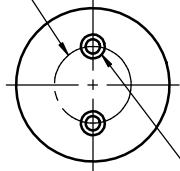
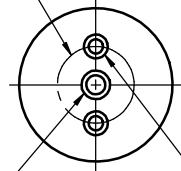
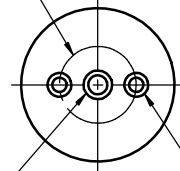
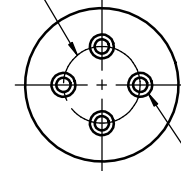
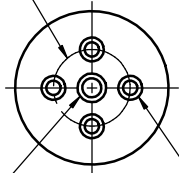
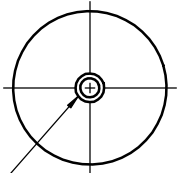
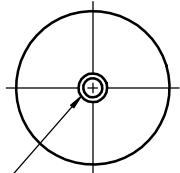
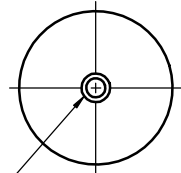
A1  1X 1/2-13 UNC ∇ 3/4	A2  ϕ 2 BCD 2X 3/8-16 UNC ∇ 5/8	A3  ϕ 2 BCD 2X 3/8-16 UNC ∇ 5/8	A4  ϕ 2 BCD 2X 3/8-16 UNC ∇ 5/8 1X 1/2-13 UNC ∇ 3/4	A5  ϕ 2 BCD 2X 3/8-16 UNC ∇ 5/8 1X 1/2-13 UNC ∇ 3/4	A6  ϕ 2 BCD 4X 3/8-16 UNC ∇ 5/8
A7  ϕ 2 BCD 4X 3/8-16 UNC ∇ 5/8 1X 1/2-13 UNC ∇ 3/4	A8  1X 3/4-10 UNC ∇ 7/8	A9  1X 5/8-11 UNC ∇ 7/8	C1  1X 3/8-16 UNC ∇ 5/8		

105-208-15	A8A8
105-208-16	A6A9
105-208-18	A1A6
105-208-19	A4A6
105-208-21	A8A9
105-208-22	A2A4
105-208-28	A4A9
105-208-30	A1A7
105-208-31	A4A7
105-208-32	A2C1
105-208-39	A6A7
105-208-41	C1C1

POLYCAST

486 SHEPPARD ST
 WINNIPEG, MB
 CANADA R2X 2P8
 www.polycast.ca

CONFIDENTIALITY

THIS DRAWING ALONG WITH INFORMATION AND RELATED DOCUMENTS MAY NOT BE DUPLICATED OR RELEASED IN WHOLE OR IN PART WITHOUT WRITTEN PERMISSION AND IS THE EXCLUSIVE PROPERTY OF POLYCAST INTERNATIONAL

PRODUCT SERIES

PII20A SERIES - 8kV/75kV BIL
 INSULATOR

SERIES NUMBER

105-208-00